

## MHHS-DEL2431 - [04a] Migration Business Process Models

Document Control			
Version	Description	Author	Date
0.1	Draft for Industry Consultation	Migration Team	18/03/2024
0.2	Revised Draft for Assurance Meeting	Migration Team	19/04/2024
1.0	Version Uplifted following MCAG Interim Approval	Migration Team	08/05/2024
1.1	Control and Monitor Process – Draft for Consultation 2	Migration Team	05/06/2024

### **Cover Note**

This document displays the proposed target state from the Migration Control Centre.

See MHHS-DEL2430 - [04] Migration Requirements and Processes for the descriptions of the processes in this document.

It shows interactions between industry participants, and it's purpose is to provide context and understand the Events and triggers that will control and govern the creation of the migration schedule,

**NOTE:**

- **Processes outside of the MCC are indicative representations ONLY.**
- **They are intended as a low-fidelity reference to show the essence of those process**
- **As a result facilitate, and elicit understanding in order to refine and develop further the MCC processes and requirements.**

It begins with the one off Activities related to the creation of the first schedule prior to M10.

- 01 Define and Design and Consult
- 02 Initialize Schedule
- 03 Maintain Schedule







The Manage Migration processes are and continue during the entire Live Migration Window.







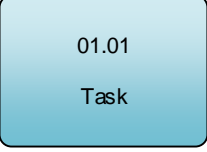
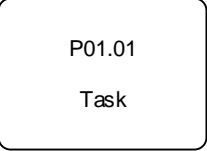

- 03 Maintain Schedule
- 04 Control and Monitor
- 05 Manage Daily Dynamic Capacity Allocation
- 06 Data Analytics and Reporting

The process ends with the close down and clean-up activities related to the MCC.

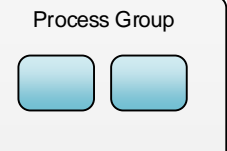
- 07 Close Down Migration

## MHHS Migration – Business Process Modelling Notation (BPMN) Key

	Start Event		Intermediate Event		End Event
			Process Link		
			Message Event		
			Multiple Triggers		
			Signal		

	<b>Task:</b> This represents a specific action or step in the process
	<b>Indicative Task:</b> Indicative activity to aid understanding and representative only
	<b>Sub-Process:</b> A collapsed process comprised of a series of other tasks/processes
	<b>Process Group:</b> An collapsed view of tasks and/or sub-processes
	<b>Exclusive (XOR) Gateway:</b> Decision to go one way or another
	<b>Parallel (AND) Gateway:</b> Initiate multiple steps
	<b>Inclusive (OR) Gateway:</b> Offers multiple paths but more flexible than the XOR
	<b>Message Flow</b>
	<b>Sequence Flow</b>
	<b>Data Object</b>

# BPM for MCC and Migration Schedule

BPM - Level 0

VERSION:

0.1

AUTHOR:

28/02/2024 by Alf Chivers

VERSION AUTHOR:

18/03/2024 by Author

## MHHS

Level 0

Business Process Model for MCC and Migration Schedule

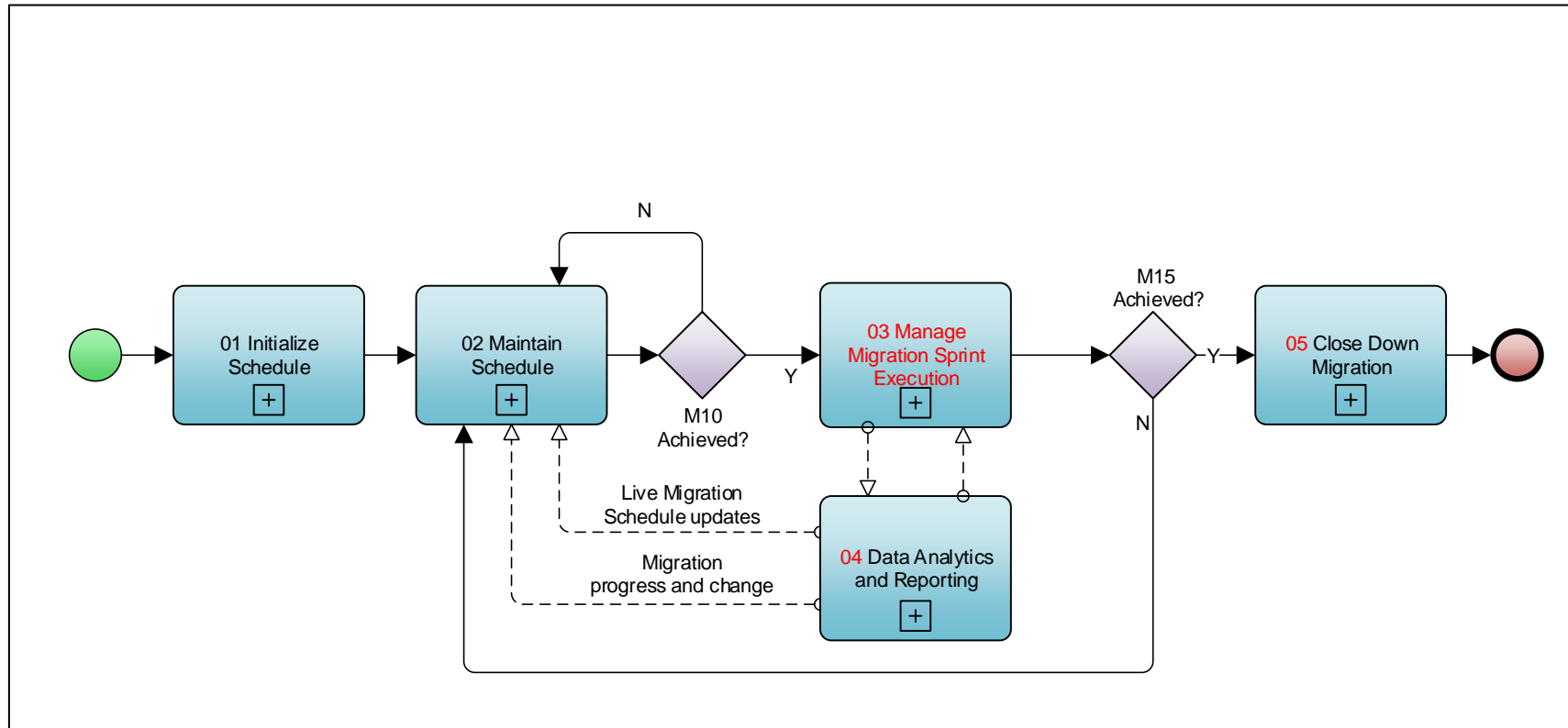

# 01. Initialise Schedule

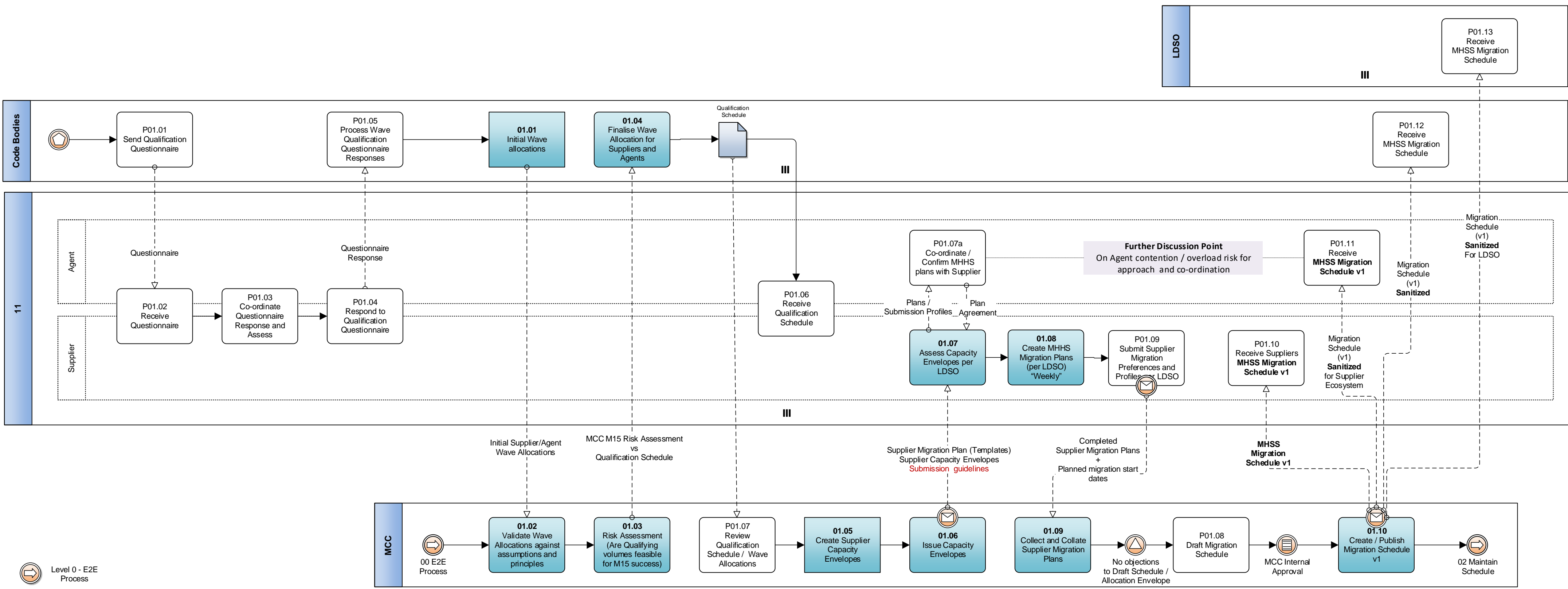

Level 0 - E2E Process

# O2 Maintain Schedule

Level 0 - E2E Process

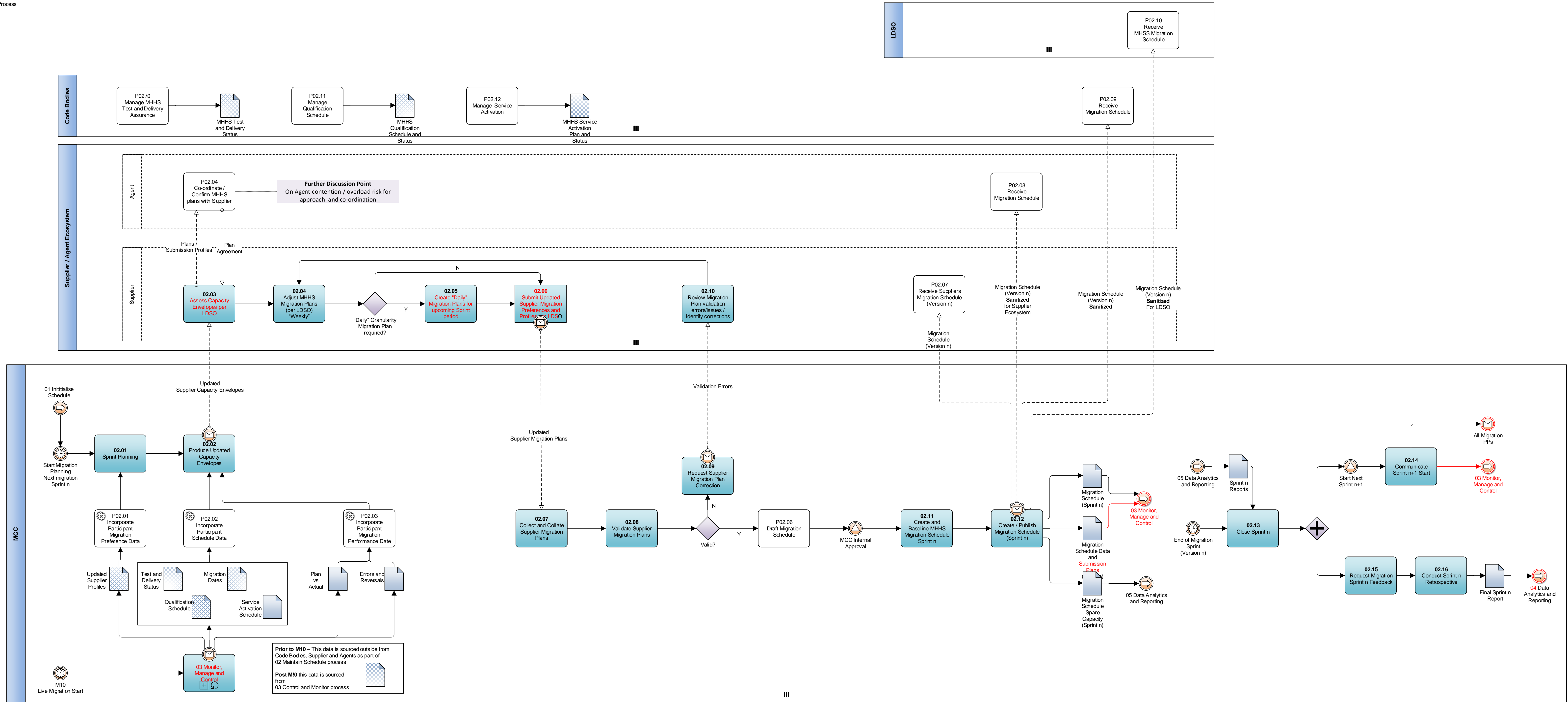

# 03 Manage Sprint Execution

BPM - Level 1

VERSION:

0.1

AUTHOR:

10/04/2024 by Alf Chivers

VERSION AUTHOR:

16/05/2024 by Author

Level 0 - E2E  
Process

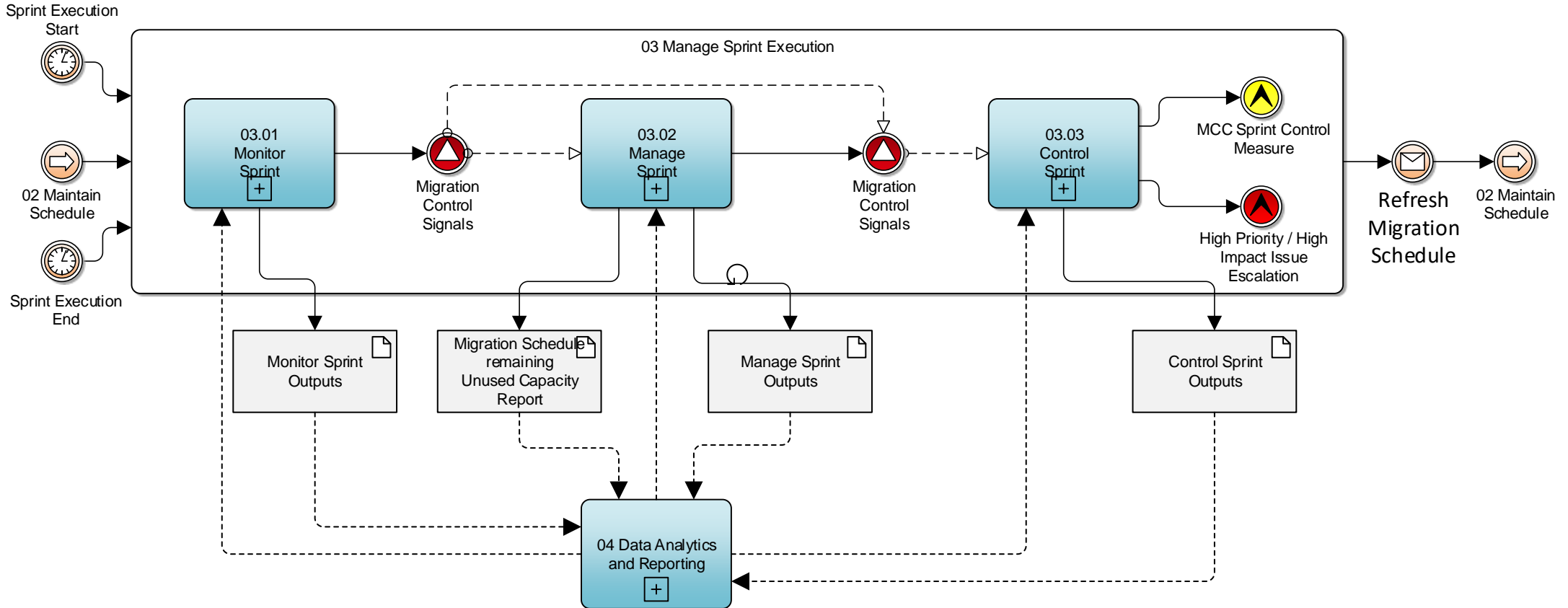

# 03.01 Monitor Sprint

BPM - Level 2

VERSION:

0.1

AUTHOR:

10/04/2024 by Alf Chivers

VERSION AUTHOR:

16/05/2024 by Author



## 03 Manage Sprint Execution

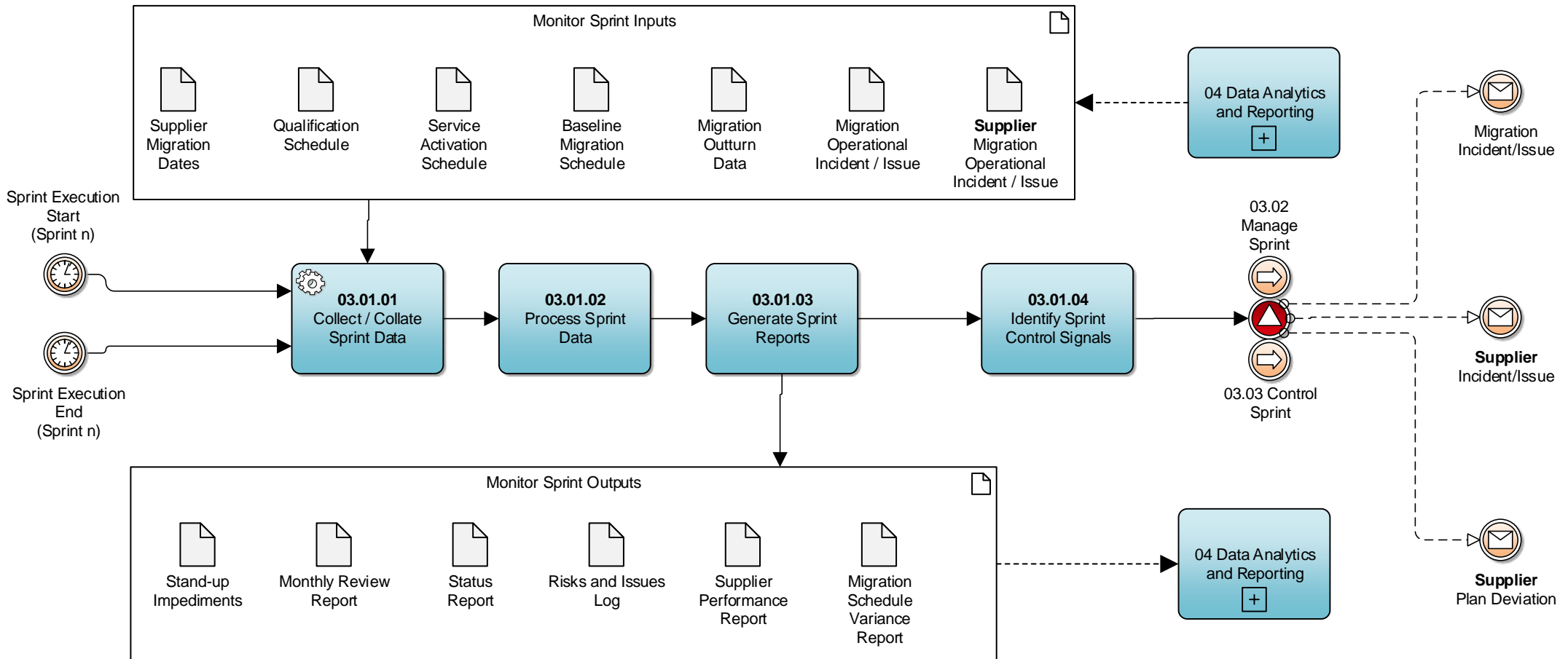

●Reports / Meetings frequency varies  
 ●Refer to:  
 - Migration Choreography  
 - Migration Reportin Catalogue

# 03.02 Manage Sprint

## 03 Manage Sprint Execution

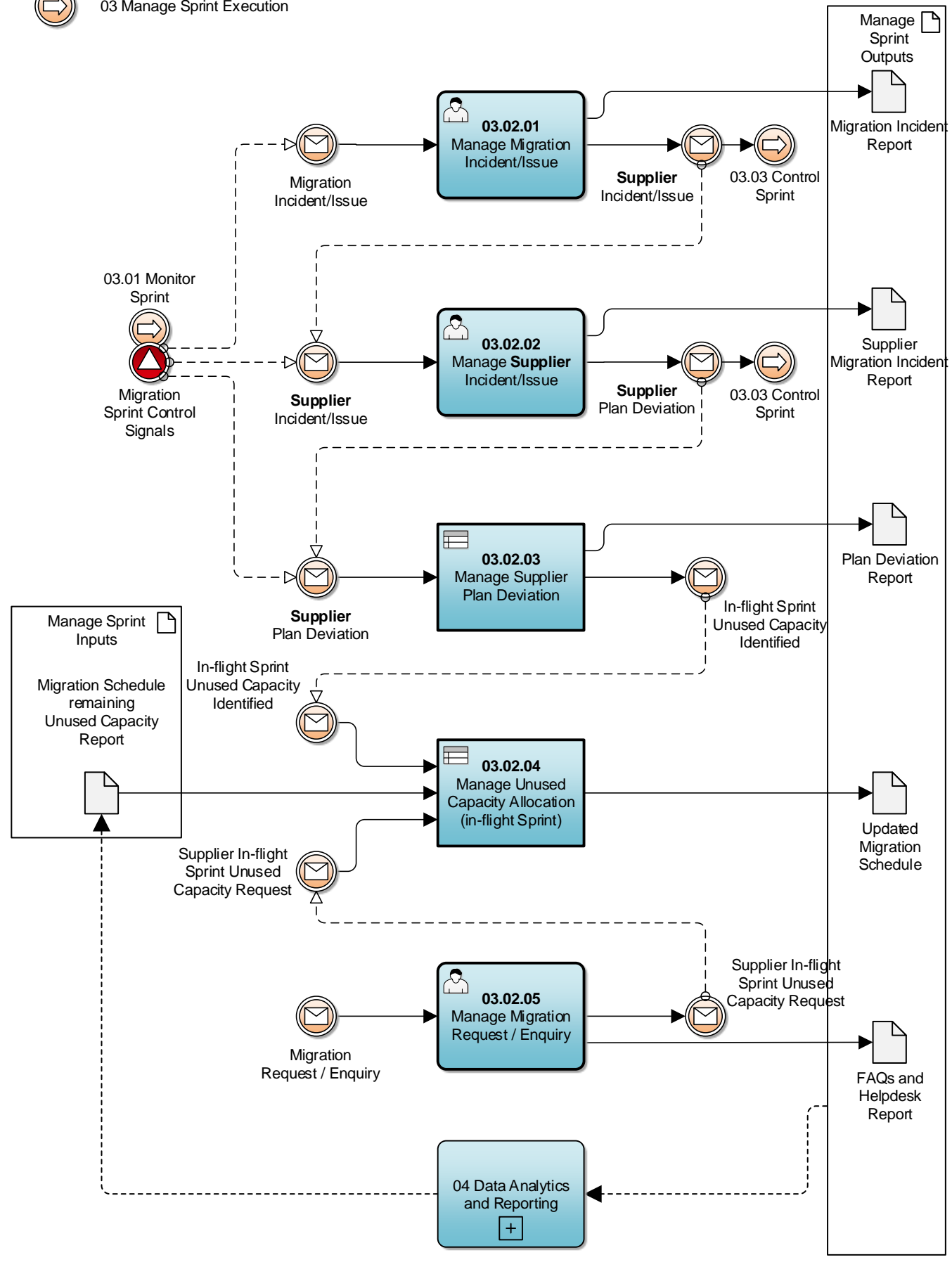

Impacts and Remediation Plans for Incidents/Issue relating to:

- Central Services
- LDSO
- Settlement
- Industry Event
- SoLR
- etc

- Migration Performance
- Threshold Breach
- Settlement
- Live Incidents, etc.

- Supplier / Agent Qualification Plan Delay
- Supplier / Agent Migration Plan Start Date Delay
- Supplier / Agent Unplanned Sprint Inclusion (**Not Allowed TBC**)
- Notified / **Unplanned** Deviations

- Capacity Removed
- UCA Added
- Aggregate
- Updated Migration Schedule Baseline

- Define Sub-process
- At beginning of Sprint (Reaining Unused Capacity Report)
- Hold and Publish Live View
- First-come first serve
- Process Accept and update plan



# 03.03 Control Sprint

BPM - Level 2	VERSION:	0.1	AUTHOR:	10/04/2024 by Alf Chivers	VERSION AUTHOR:	16/05/2024 by Author
---------------	----------	-----	---------	---------------------------	-----------------	----------------------

## 03 Manage Sprint Execution

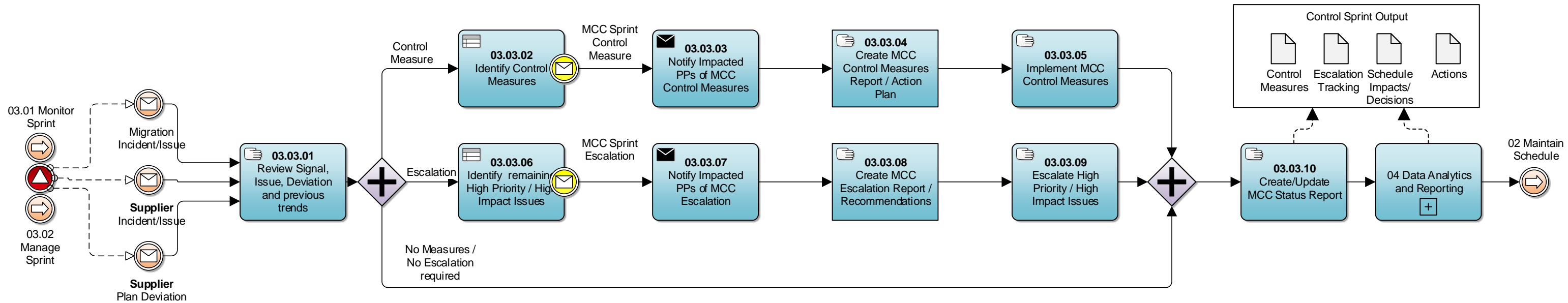

•Links to Governance Framework  
 •Planned vs Unplanned Deviations  
  
 QUESTIONS  
 - treatment of planned vs unplanned (Notified / un notified) deviations  
 - Is there a limit of how many notified or overall volume impacts  
 - What metrics etc to decide on escalation  
 - How to we define materiality  
 - How do we ensure no gaming of KPI ( As supplier notifies on a regular basis going to submit planned)  
 - We should have an overall Sprint performance metrics to identifying ongoing sub-par performance.

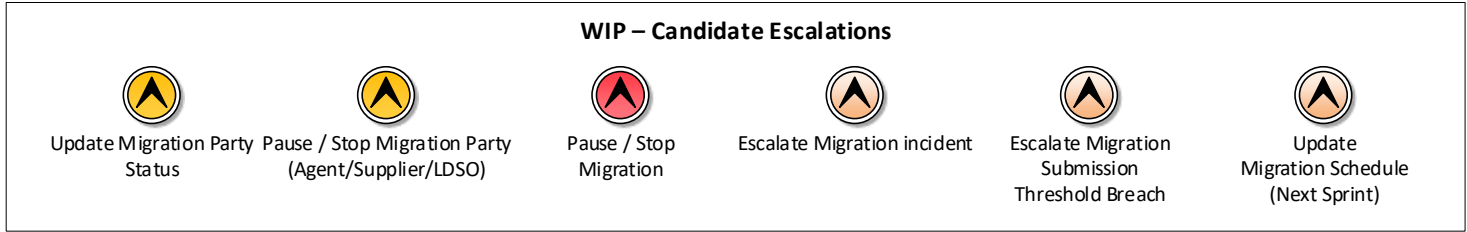

# 05 Data Analytics and Reporting

BPM - Level 1

VERSION:

0.1

AUTHOR:

26/02/2024 by Alf Chivers

VERSION AUTHOR:

27/02/2024 by Author



Level 0 - E2E  
Process

**Supports Processes:**

02 Maintain Schedule

03 Monitor, Manage and Control

**Provides data used in:**

[05] Migration Choreography

[06] Migration Governance and Escalation Framework

## 06 Close Down Migration

LEVEL 1: BPMN

VERSION:

0.1

AUTHOR:

26/02/2024 by Alf Chivers

VERSION AUTHOR:

27/02/2024 by Author



Level 0 - E2E  
Process

To be included in future consultations